

K1MICROBEAD011102191MAN

UK
English

EVOLUTION
AQUA

INNOVATION IN WATER



K1MicroBead

INSTALLATION AND INSTRUCTION MANUAL

**PLEASE READ INSTALLATION INSTRUCTIONS
THOROUGHLY BEFORE INSTALLATION.**

PLEASE NOTE: Do not operate the multi-port valve with the circulating pump switched on. The ball valve on the air blower line must be closed when the circulating pump is switched on.

INTRODUCING THE K1 MICRO BEAD FILTERS

The **K1 Micro Bead Filters** are a range of **pressurised systems** that deliver incredible levels of filtration for ponds. By using the new **K1 Micro** filter media instead of conventional beads, these filters offer **class-leading mechanical** filtration along with unparalleled biological filtration. This is due to the vast **PROTECTED SURFACE AREA** of K1 Micro filter media. The media also **improves flow** through the filter meaning **lower energy pumps** can be used and a consistent flow rate can be achieved.

For more detailed information on K1 Micro visit our website www.evolutionaqua.com

Please read this instruction manual carefully from start to finish before attempting to install your new **K1 Micro Bead Filter**.



CONTENTS

K1 Micro Bead Filter parts list	PAGE 4
Specifications	PAGE 5
K1 Micro Bead Filter dimensions	PAGE 6
MPV and Blower Pipework Fittings	PAGE 7
How the K1 Micro Bead Filter works	PAGE 8
The Multi-Port Valve	PAGE 9
K1 Micro Bead Filter installations	PAGE 10
K1 Micro Bead Filter set-up	PAGE 11
K1 Micro Bead Filter installations	PAGE 15
K1 Micro Bead Filter cleaning instructions	PAGE 16
Quick cleaning / backwash instructions	PAGE 17
How to get the best from your K1 Micro Bead Filter	PAGE 18
Winter Maintenance	PAGE 19
Troubleshooting	PAGE 20
Warranty	PAGE 21
Warranty Card	PAGE 22

K1 MICRO BEAD FILTER PARTS LIST

Your K1 Micro Bead Filter comes complete with the following items:



1) K1 MICRO BEAD FILTER
(Including lid)



2) MULTI-PORT VALVE + BALL VALVE + FITTINGS
20" model supplied with 1½" MPV.
24", 30" and 36" models supplied with 2" MPV.



3) AIR BLOWER
20" models supplied with 200W Air Blower.
24" to 36" models supplied with 300W Air Blower.



4) PRESSURE GAUGE AND FITTINGS

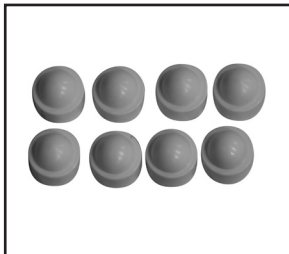

5) COVER CAPS FOR LID



6) INLET AND OUTLET THREADED COLLARS

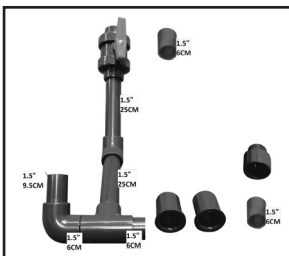

7) PIPEWORK & FITTINGS (1½")
For 20" models.

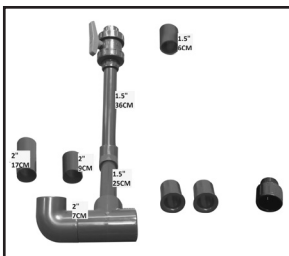

8) PIPEWORK & FITTINGS (2")
For 24", 30", 36" models.

K1 MICRO BEAD FILTER SPECIFICATIONS

MODEL NO.	K1MICROBEAD20	K1MICROBEAD24	K1MICROBEAD30	K1MICROBEAD36
Diameter	20"	24"	30"	36"
Volume of K1 Micro Media	50 Litres	100 Litres	150 Litres	250 Litres
Multi-Port Valve size	1½"	2"	2"	2"
Maximum pond size	4,000 UK Gallons	8,000 UK Gallons	12,000 UK Gallons	20,000 UK Gallons
	18,000 Litres	36,000 Litres	54,500 Litres	91,000 Litres
	4,800 US Gallons	9,600 US Gallons	14,500 US Gallons	24,000 US Gallons

The maximum working pressure of all K1 Micro Bead Filters is 2.5 Bar.

AIR BLOWER SIZE

- K1 MICRO BEAD 20 FILTER (20") = 200W Air Blower
- K1 MICRO BEAD 24 FILTER (24") = 300W Air Blower
- K1 MICRO BEAD 30 FILTER (30") = 300W Air Blower
- K1 MICRO BEAD 36 FILTER (36") = 300W Air Blower



Figure 1a.

BALL VALVE FITTED BELOW THE AIR BLOWER

On the pipe run between the MPV and the Air Blower there is a 1½" ball valve fitted.



IMPORTANT PLEASE READ



The ball valve handle must always be closed when the circulating pump is switched on. This indicates that the ball valve is **CLOSED**.

This is designed to prevent water flowing back into the air blower.

Only open the ball valve when the pump is switched off and before operating the air blower.

**FAILURE TO FOLLOW THESE INSTRUCTIONS
MAY INVALIDATE THE WARRANTY.**

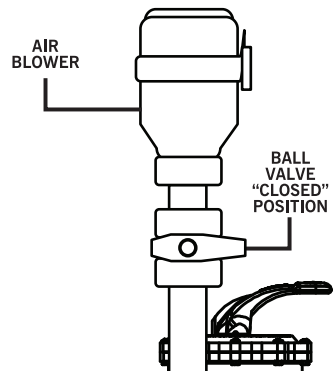

Figure 1b

DIMENSIONS

K1 MICRO BEAD 20 FILTER

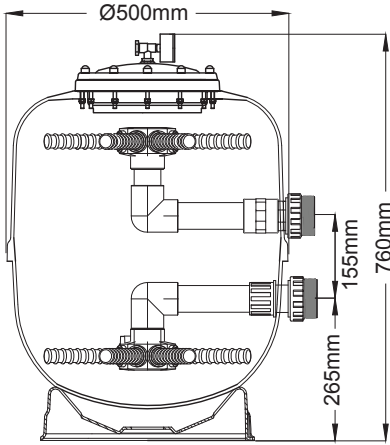

Figure 2a.

K1 MICRO BEAD 24 FILTER

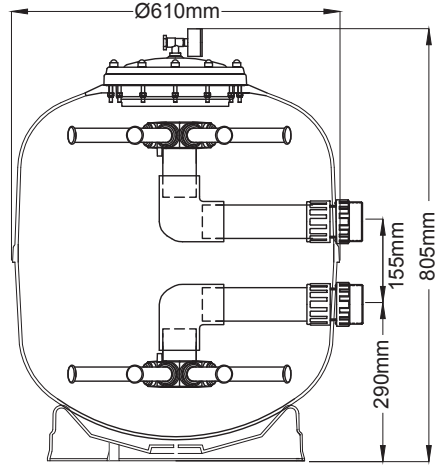

Figure 2b.

K1 MICRO BEAD 30 FILTER

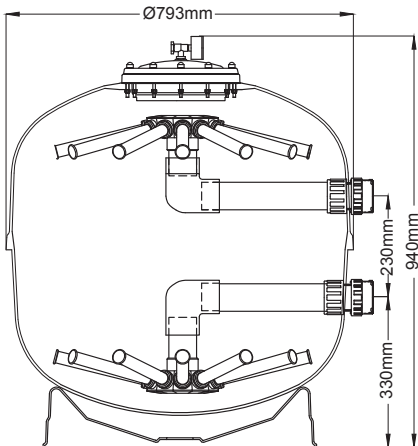

Figure 3a.

K1 MICRO BEAD 36 FILTER

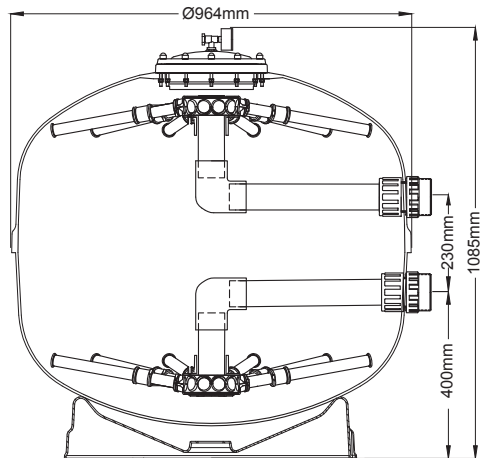
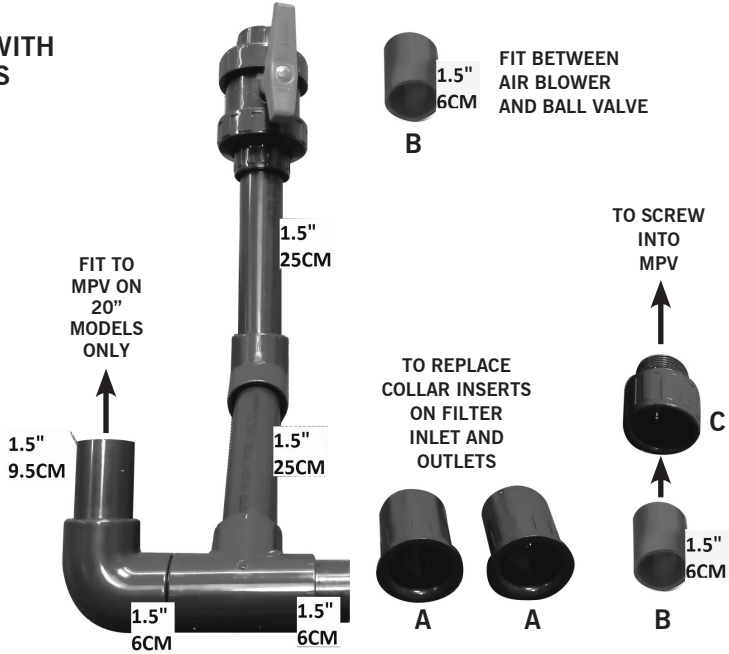

Figure 3b.

MPV AND BLOWER PIPEWORK FITTINGS

SUPPLIED WITH 20" MODELS

Figure 4.



SUPPLIED WITH 24", 30" AND 36" MODELS

Figure 5.

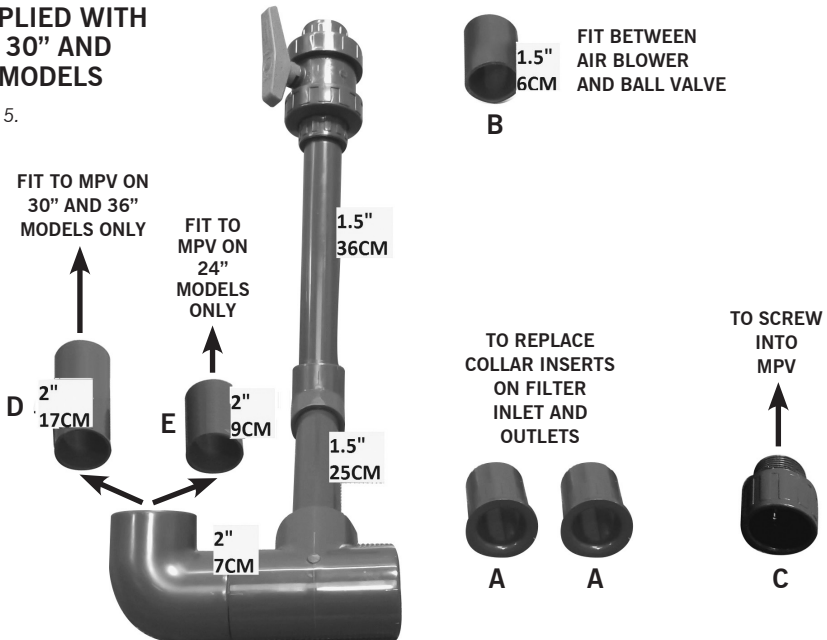

HOW THE K1 MICRO BEAD FILTER WORKS

Water enters the filter from the pond into the multi-port valve (MPV) and is directed to the bottom of the unit. As the water is pumped through the K1 Micro Bead Filter, dirt, debris and waste are trapped by the K1 Micro and then the massive protected surface area housing the filter bacteria biologically breaks down the Ammonia and Nitrite into Nitrate. The filtered water is returned to the top of the unit through the multi-port valve and back to the return line flowing back into the pond.

Figure 6a.

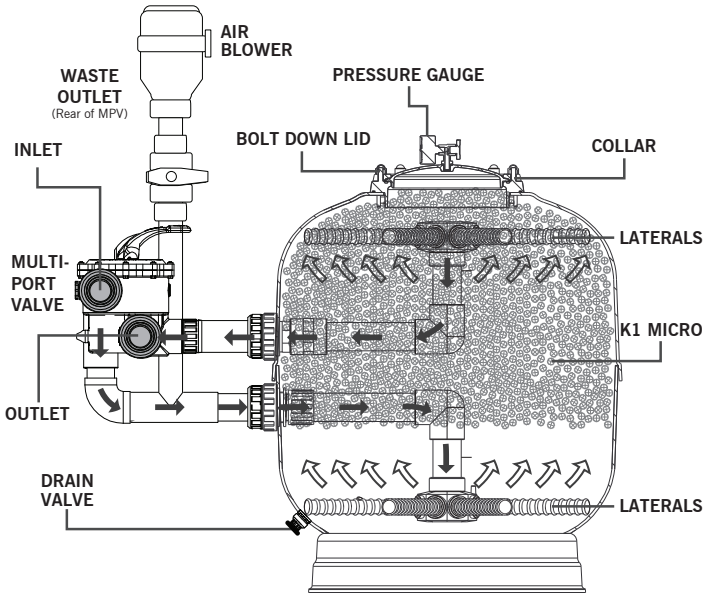
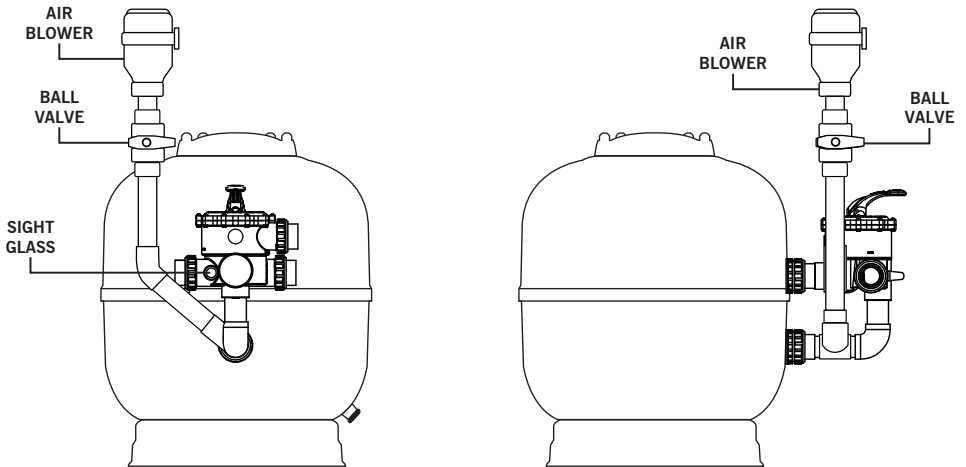

Figure 6b.



THE MULTI-PORT VALVE

The K1 Micro Bead Filter is operated by a multi-port valve. This multi-port valve functions by pushing down on the handle, turning it and relocating it into one of the operating positions shown on the multi-port valve (see figure 7). **The valve must always be operated with the circulating pump switched OFF. The ball valve positioned below the air blower must be closed when the pump is running.** Below we offer an explanation of each of the multi-port valve's functions:

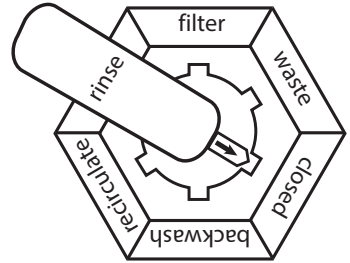

Figure 7.

1) FILTER: Incoming water from the pond enters the MPV at point (A) (see figure 8). The water enters the vessel at point (D) then flows upwards through the K1 Micro filter media to the top exit bar (B). The filtered water is returned through the multi-port valve at point (C) and back into the pond.

2) BACKWASH: This is the position the multi-port valve should be in for cleaning the K1 Micro filter media. With the valve in this position, water flow is reversed through the filter bed so that the water flow is directed to the top of the unit (B) and exits the unit at (D) and goes out to the waste line (E).

3) RINSE: This is the position the multi-port valve should be in for agitating the K1 Micro filter media. With the valve in this position, air (supplied by the air blower) is used to agitate the filter media. Later on in the cleaning process, water is used to rinse the K1 Micro and exit to waste (E).

4) WASTE: This is the position the multi-port valve should be in to allow water to by-pass the filter bed and drain to waste (E). With the multi-port valve in this position, the water flow is directed straight to waste by-passing the unit. This function can be used to lower the water level or for vacuuming your pond without soiling the filter.

5) RE-CIRCULATE: This is the position the multi-port valve should be in to allow water to completely by-pass the filter. With the valve in this position, water is pumped from the pond to the multi-port valve and directly back to the pond, without flowing through the K1 Micro Bead Filter. This is particularly handy if you are treating your pond.

6) CLOSED: This is the position the multi-port valve should be in for closing all flow to the filter. This position is not to be used with the pump running.

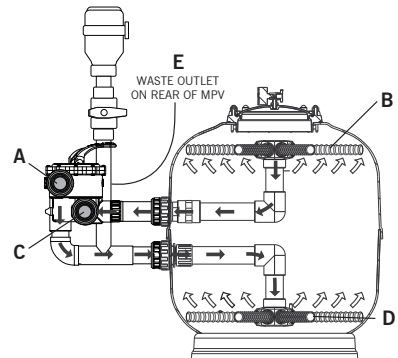

Figure 8.

Do not operate the multi-port valve with the circulating pump switched on. The ball valve must be closed when the circulating pump is running.

K1 MICRO BEAD FILTER INSTALLATIONS

The K1 Micro Bead Filter is a versatile unit. It can be used:

- as a filter on its own
- in conjunction with a pre-filter
- on skimmer lines
- as a polisher at the end of a system
- on pump-fed systems
- on gravity fed systems
- installed at any height or location

Here is a diagram showing a typical installation for a K1 Micro Bead Filter:

Recommended Installation

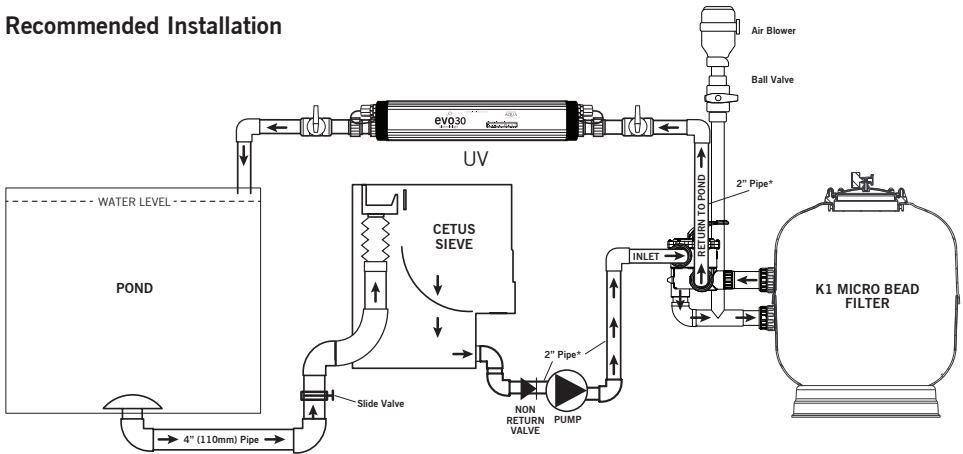

Figure 9.

The K1 Micro Bead Filter can be installed as shown above if you are planning to use a pre-filter such as the Evolution Aqua Cetus Sieve. If you are not planning to use a pre-filter we highly recommend that you fit a strainer basket to the pump. This will prevent leaves, string algae etc. from entering the filter and pump.

** It is recommended that all pipework on the pump side (from the pump to the filter and back to the pond) is installed on 2" pipe. Please note on the K1MicroBead20 Filter you will have to reduce your pipe down to 1½" to connect to the multi-port valve. This will ensure that your pump is working at its maximum flow.*

**Do not operate the multi-port valve with the circulating pump switched on.
The ball valve must be closed when the circulating pump is running.**

K1 MICRO BEAD FILTER SET-UP

We recommend following these instructions to install the K1 Micro Bead Filter.

Remove the K1 Micro Bead Filter, the multi-port valve, air blower, pipe work, and fittings from the box, and familiarise yourself with the parts. (See page 4 and 7).

FITTING THE INLET AND OUTLET THREADED COLLARS

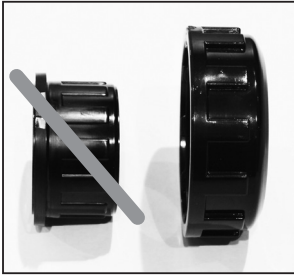

Discard the inserts supplied with the threaded collars.

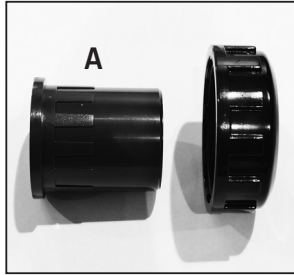

Instead use the inserts (A) supplied inside the pipework kit bag. (See page 7)



Fit the O-ring into the seal on the outlet.



Fit the threaded collar, with the insert (A) onto the outlet.



Tighten up the collar. **HAND TIGHTEN ONLY.**



Now fit the O-ring into the seal on the inlet.



Fit the threaded collar, with the insert (A), onto the outlet, and tighten up.



Tighten up the collar. **HAND TIGHTEN ONLY.**



Discard the inserts supplied with the threaded collars.

K1 MICRO BEAD FILTER SET-UP

FITTING THE MULTI-PORT VALVE

PLEASE NOTE: We strongly recommend that you fit all pipework dry to check that you have fitted them correctly before permanently fixing them with solvent weld adhesive.

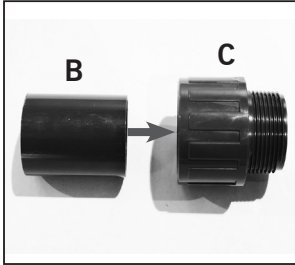

ONLY ON 20" MODELS
Glue 6cm pipe (B) into the female end of the threaded insert (C)



ON ALL MODELS
Screw insert (C) into the female thread on the MPV.
HAND TIGHTEN ONLY.

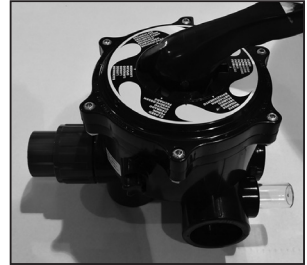

The MPV assembly should look like this. *(Image shows 20" model version)*

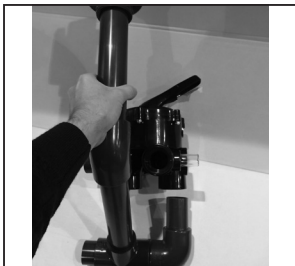

ONLY ON 20" MODELS
Take the pre-assembled pipework (with ball valve) and insert the end with the piece of 1½" pipe into the MPV. Glue connections.

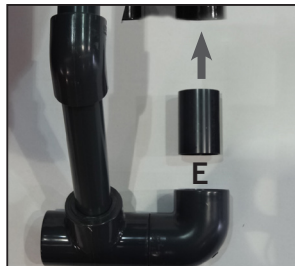

ONLY ON 24" MODELS
Take the pre-assembled pipework (with ball valve) and insert 9cm pipe (E) between the MPV and 2" Elbow. Glue connections.



ON 30" AND 36" MODELS
Take the pre-assembled pipework (with ball valve) and insert 17cm pipe (D) between the MPV and 2" Elbow. Glue connections.



Take the MPV assembly and pipework and fit to the inlet and outlet on the filter. Glue connections.



The filter set up should now look like this

K1 MICRO BEAD FILTER SET-UP

FITTING THE BLOWER (DO NOT expose blower to rain fall or water ingress)

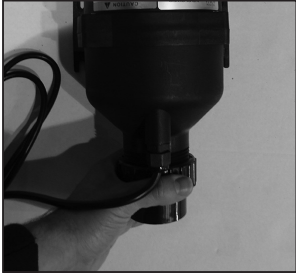

Screw the insert and collar onto the blower. **HAND TIGHTEN ONLY.**



Glue the reducing pipe (B) in place in the ball valve and glue into the blower.

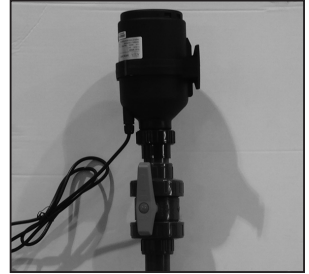

The assembly should look like this.

FITTING THE PRESSURE GAUGE



Take the component parts needed to fit the pressure gauge onto the filter lid

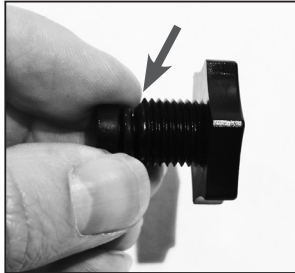

Fit the smallest washer between the thread and the plug on the valve

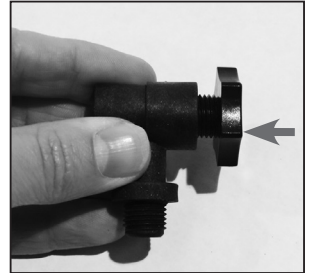

Screw valve into the larger female threaded end on the elbow

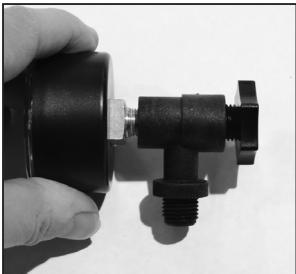

Screw the pressure gauge into the smaller threaded end on the elbow.



Fit the larger washer on the threaded end ready to screw into the lid.



Screw the pressure gauge assembly into the lid.
DO NOT OVER TIGHTEN.

K1 MICRO BEAD FILTER SET-UP

REMOVING AND FITTING THE LID



Carefully undo the M8 size nuts and washers holding the lid collar in place.

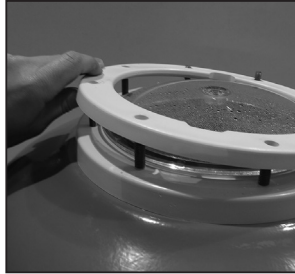

Carefully lift the collar off the threads.

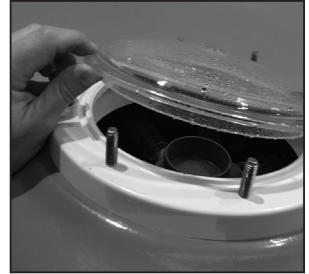

Remove the clear plastic lid.



With the lid off, familiarise yourself with the internals of the filter.



For your size of filter, you should add the recommended amount of K1 Micro straight into the filter.

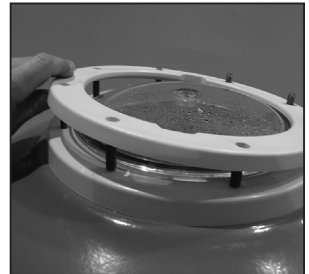

Refit the clear plastic lid and the collar.



Re-fit the nuts and washers around the lid and hand tighten the nuts.



Then tighten alternate nuts with a spanner in sequence **i.e.** at 12 'o' clock and 6 'o' clock then 1 'o' clock and 7 'o' clock. Tighten to a reasonable degree. **DO NOT OVER TIGHTEN.**



Fit the plastic caps over the top of the nuts to protect the threads and nuts.

K1 MICRO BEAD FILTER INSTALLATION INSTRUCTIONS

We recommend following these instructions to install the K1 Micro Bead Filter.

1. Remove the K1 Micro Bead Filter, the multi-port valve, air blower, pipe work, and fittings from the box, and familiarise yourself with the parts. (See page 4 parts list).
2. Set up the filter as shown on pages 11 to 14, ready for installation.

IMPORTANT: The unit must be installed on a flat, level base, on firm ground or equivalent. Ensure the ground will not subside and strain pipework. We recommend using a flat solid concrete surface as a base for installation. Depending on the model of your K1 Micro Bead Filter, the dimensions of this base will be different.

3. Position the filter as close as possible to the pond.
4. The filter should also be in a location that is free from flooding, is away from sumps, guttering, garden hollows and areas that may experience sub-zero conditions etc.
DO NOT position the blower in an area where it is exposed to rain-fall or water ingress.
5. Allow room all the way around the K1 Micro Bead Filter to enable easy maintenance and servicing. Do not install the unit in a tight space.
6. Make sure the multi-port valve and fittings are properly positioned. Hand tighten the unions only. The multi-port valve must not move during operation.
7. Make pipe connections onto the valve. Pump line (inlet), return line and waste lines are marked on the valve. A ball valve, slide valve or non-return valve needs to be installed on the pumps suction line from the pond / pre-filter to the pump. We highly recommend a non-return valve (see figure 9). Refer to your pump manufacturer's manual to see if the pump is self-priming. For the avoidance of doubt install your pump below the pond water level. Allow a full 24 hours for all glued pipework joints to harden.
8. Install a UV on the return line back to the pond.
9. Connect the air blower to the manifold (Figure 6b). Ensure the ball valve is attached, connected properly and the handle can be moved without restriction for cleaning. The air blower should be installed higher than the top of the filter. The air blower is only operated during the cleaning procedure. **IMPORTANT: The ball valve must be in the CLOSED position when the circulating pump is running.**
10. If you have not already done so, remove the lid and pour the K1 Micro into the filter from the top. Then re-fit the lid (as shown on page 14).
11. Set the multi-port valve to the **FILTER** position. Turn on the pump and allow the unit to fill with water. Check for any leaks. Your K1 Micro Bead Filter will be operational.
12. When the unit is running, the biological side of the K1 Micro Bead Filter will take approximately 8 weeks to mature. We recommend adding **PUREPOND** to the unit to drastically speed up this process.

**Do not operate the multi-port valve with the circulating pump switched on.
The ball valve must be closed when the circulating pump is running.**

K1 MICRO BEAD FILTER CLEANING INSTRUCTIONS

Do not operate the multi-port valve with the circulating pump switched on. The ball valve must be closed when the circulating pump is running.

The function of rinsing and backwashing is to separate the deposited particles of waste from the filter media and to flush these particles to waste. On the initial start up of the unit it is sound advice to let the unit run for a full 2 weeks before you perform the first rinse and backwash.

Frequency of cleaning will depend on your pond size, feeding rates, algae levels, loss of flow etc. We recommend, after the first 2 weeks, to rinse and backwash the unit once or twice a week. The instructions below are relevant for installations that include a non-return valve on the pumps suction line. If you have installed a slide valve or ball valve then you will need to close this valve every time you switch the pump off.

CLEANING - RINSE & BACKWASH INSTRUCTIONS

Follow the instructions below to clean (rinse and backwash) the K1 Micro Bead Filter.

1. Switch off the pump.
2. Turn the handle on the ball valve fitted just below the air blower to **OPEN**.
3. Turn the multi-port valve to the **RINSE** position.
4. Switch the air blower on for 2 minutes. This will agitate the K1 Micro media. Some water will exit the filter to waste. After 2 minutes switch off the blower.
5. **IMPORTANT:** Turn the handle on the ball valve fitted just below the blower to **CLOSE**.
6. Leaving the MPV in the **RINSE** position, loosen one of the air pressure release valves and switch on the water pump. Look at the sight glass on the MPV and when the water runs clear, switch off the pump.
7. Turn the MPV to the **BACKWASH** position. Switch the pump on and look at the sightglass on the manifold. Water is going to waste. After a very short while, the sight glass will run dirty. When this runs clear, switch the pump off. It is important when performing the BACKWASH that the filter is full with water to remove the waste properly. Release any trapped air by using the air pressure release valve. This will keep the unit filled with water.
8. Move the MPV to the **RINSE** position again. Switch on the water pump only, and bleed off any air using the air pressure valve and again look at the sight glass. This will flush out any remaining dirt in the unit and pipework. Failure to do this may result in a cloud of debris going back to the pond. When water is running clear, switch off the pump.
9. Move the MPV to the **FILTER** position and switch the pump back on, ensuring all the air has been bled from the unit.

The filter is now clean and fully operational.

In extreme cases when the unit has not been backwashed for some time, extend the length of time the blower is running for a more thorough clean or perform a couple of extra rinses. In extreme conditions, performing a backwash first and then following the cleaning instructions can free up any packed media.

Do not operate the multi-port valve with the circulating pump switched on. The ball valve must be closed when the circulating pump is running.

QUICK CLEANING / BACKWASH INSTRUCTIONS

Do not operate the multi-port valve with the circulating pump switched on. The ball valve must be closed when the circulating pump is running.

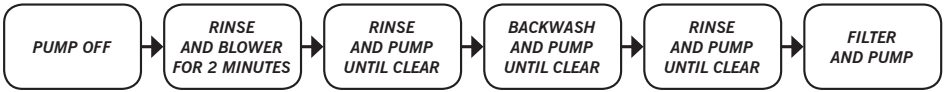

- Switch **PUMP OFF**.
- Turn the ball valve to **OPEN**.
- Turn the MPV to the **RINSE** position.
- Switch the **AIR BLOWER ON** for 2 minutes.
- After 2 minutes switch the **AIR BLOWER OFF**.
- Turn the ball valve to **CLOSE**.
- Leave the MPV in the **RINSE** position, switch the **WATER PUMP ON**.
- When water runs clear through the sight glass, switch the **WATER PUMP OFF**.
- Turn the MPV to the **BACKWASH** position.
- Switch the **WATER PUMP ON**.
- When water runs clear through the sight glass, switch the pump **WATER PUMP OFF**.
- Move the MPV to the **RINSE** position.
- Switch the **WATER PUMP ON**.
- When water is running clear, switch off the **WATER PUMP OFF**.
- Move the MPV to the **FILTER** position.
- Switch the **WATER PUMP ON**.
- The filter is now clean and fully operational.

HOW TO GET THE BEST FROM YOUR K1 MICRO BEAD FILTER

The biological side of the filter can take anywhere between 4 to 8 weeks to fully mature. To speed up this process, add the award winning **PUREPOND** to the filter.

Top tips for optimum biological performance:

- For best results for the prevention of green water use an evoUV pond clarifier. A UV-C is recommended on every pond installation.
- Maintain a stable pond pH of 7 or higher.
- Maintain a pond Nitrate reading of 50mg/l or less.
- Always dechlorinate your mains water. Use an Evolution Aqua Dechlorinator for removal of harmful chlorine when topping up with mains water.
- Add **PUREPOND** to the filter media inside the K1 Micro Bead Filter.
- Feed your fish Evolution Aqua's own food range which has been designed to create less fish waste.

Ask your local EA dealer for advice.

WINTER MAINTENANCE

Shutting down for Winter

If you live in an area, or have installed the K1 Micro Bead Filter in a position that will experience sub zero temperatures, you may decide to shut your filter down for the Winter. Here is a guide on how to do this:

1. Perform a thorough rinse and backwash of the filter, then move the MPV to the **“CLOSE”** position.
2. Close any in-line valves before and after the K1 Micro Bead Filter.
3. Open the air pressure release valve at the top of the unit.
4. Open the drain plug at the base of the unit. Water will drain from the vessel.
5. Loosen all connections and drain water from valves, pipes, pumps and UVs. Ensure that no water is trapped. Remember water can expand by 10% when it is ice and can cause permanent damage.

Starting up for Spring

1. Add **PUREPOND** balls to the K1 Micro Bead Filter.
2. Tighten up all connections that were undone over Winter, including the drain plug.
3. Tighten the air pressure release valve.
4. Move the multi-port valve to the **FILTER** position and switch pump on. Check for leaks. Your K1 Micro Bead Filter is fully operational.
5. The K1 Micro Bead Filter Media will mature quickly. Monitor water readings for the first 2 weeks.

TROUBLE SHOOTING

<p>Dirty Water</p>	<ol style="list-style-type: none"> 1. Insufficient filtration time 2. Low flow 3. Dirty filter requires rinsing and backwashing 4. Pump has blocked. 5. Inlet line is blocked. 6. Pump is not primed. 7. Incorrect water chemistry. Check pH and other water readings. Check UV is working correctly (replace UV bulbs older than 6 - 12 months). 8. Clogged or channelled media. Perform an extra long rinse and backwash.
<p>Short filtration cycles</p>	<p>Too much algae. Excessive water flow and pressure. Check pump size. Overloaded with fish. Excessive feeding. Filter blocked through calcium.</p>
<p>Above normal or excessive force is needed to operate the multi-port valve</p>	<p>Scoring or jamming with foreign matter or debris. If this condition persists after rinsing, disassemble the valve to clear. Continued operation may result in leaking due to damage to the multi-port valve (spider gasket). See dealer or installer.</p>
<p>Filter media has gelled / stuck together</p>	<ul style="list-style-type: none"> • Switching the Air Blower ON and OFF 2 or 3 times and performing multiple rinses can free up media. • Performing a backwash prior to following the cleaning instructions can free up the media. • Operating the filter on re-circulate will determine if the restriction is in the filter. • If you don't succeed when following the two points above, switch off the pump, isolate and drain the filter. Manually drain the filter, remove the lid and inspect the inside of the unit. The media may need to be removed and cleaned.

WARRANTY

Your K1 Micro Bead Filter comes with a one year warranty. To activate an extra one year warranty please complete and tear out the warranty card and send it to the address below.

Warranties

Evolution Aqua,
Kellet Close,
Wigan,
Lancashire,
WN5 0LP

WARRANTY

1. Your K1 Micro Bead Filter is covered by your warranty for 1 year from the date of purchase (2 years if the warranty card is correctly completed and returned) provided that:

- a. It is installed, operated and regularly maintained in accordance with the instruction manual.
- b. Any warranty repairs to the K1 Micro Bead Filter must be undertaken by Evolution Aqua Ltd or its authorised representatives.
- c. A proof of purchase will be required when making a warranty claim.

2. Though the warranty period may not have expired, payment for repairs must be made in the following cases:

- a. When the fault is due to misuse or unauthorised repairs have been attempted.
- b. When the fault is due to fire, natural disaster, act of God etc.
- c. If the warranty has been lost, incorrectly completed or details fraudulently changed.

Evolution Aqua Ltd. accepts no responsibility or liability for any consequential loss caused by or arising from the use of any Evolution Aqua products. Therefore, any dispute arising from the provisions of the warranty will be dealt with under the laws of England and Wales subject to the exclusive jurisdiction of the English Courts.

WARRANTY CARD



K1MicroBead WARRANTY CARD

WARRANTY PROVISIONS

1. Your K1 Micro Bead Filter is covered by your warranty for 1 year from the date of purchase (2 years if the warranty card is correctly completed and returned) provided that:

- a. It is installed, operated and regularly maintained in accordance with the instruction manual.
- b. Any warranty repairs to the K1 Micro Bead Filter must be undertaken by Evolution Aqua Ltd or its authorised representatives.
- c. A proof of purchase will be required when making a warranty claim.

2. Though the warranty period may not have expired, payment for repairs must be made in the following cases:

- a. When the fault is due to misuse or unauthorised repairs have been attempted.
- b. When the fault is due to fire, natural disaster, act of God etc.
- c. If the warranty has been lost, incorrectly completed or details fraudulently changed.

Evolution Aqua Ltd. accepts no responsibility or liability for any consequential loss caused by or arising from the use of any Evolution Aqua products. Therefore, any dispute arising from the provisions of the warranty will be dealt with under the laws of England and Wales subject to the exclusive jurisdiction of the English Courts.

**ACTIVATE YOUR 1 YEAR EXTRA FREE WARRANTY COVER,
COMPLETE THE FORM & POST IT TODAY,
OR GO TO www.evolutionaqua.com
AND COMPLETE ONLINE.**

WARRANTY CARD



Your Name: _____

Customer Address: _____

Postcode: _____

Country: _____

Tel: _____

Mobile: _____

Email _____

Purchased From: _____

Address: _____

Postcode: _____

Country: _____

Tel: _____

Web: _____

Date of Purchase: / / _____

Model: _____

Serial Number: _____

I have read and accept the terms and conditions listed in the warranty card, and understand the obligations of the Customer under this warranty.

Signature: _____ Date: / / _____

Returning this registration form will amount to your consent for us to disclose your details and other personal information to other companies within the Evolution Aqua group including any subsidiary company or subcontractor of Evolution Aqua for the purposes of performing our obligations under the warranty. Evolution Aqua Ltd. may contact you in the future with product updates or offers, which may be of interest to you. If you do not wish to receive this information please tick this box.

NOTES

Evolution Aqua are the award winning pond filtration manufacturer who put innovation, research and development at the top of their agenda. With a proven track record for delivering the latest technology to the aquatics and fish farming markets - we are the first choice for everyone from the general hobbyist to the serious fishkeeper. Find out more about the K1 Micro Bead Filter and all of our other innovative products at www.evolutionaqua.com. The difference is clear.

EVOLUTION AQUA

INNOVATION IN WATER

Evolution Aqua Ltd

Evolution House
Kellet Close
Wigan
Lancashire
United Kingdom
WN5 0LP

t: +44 (0) 1942 216554

f: +44 (0) 1942 418 489

e: info@evolutionaqua.com

w: www.evolutionaqua.com